

ART. 8851					
CODICE	Ø1	Ø2	A	B	C
8851 30	M33x1,5	24x19	38	30	18

Quote espresse in mm

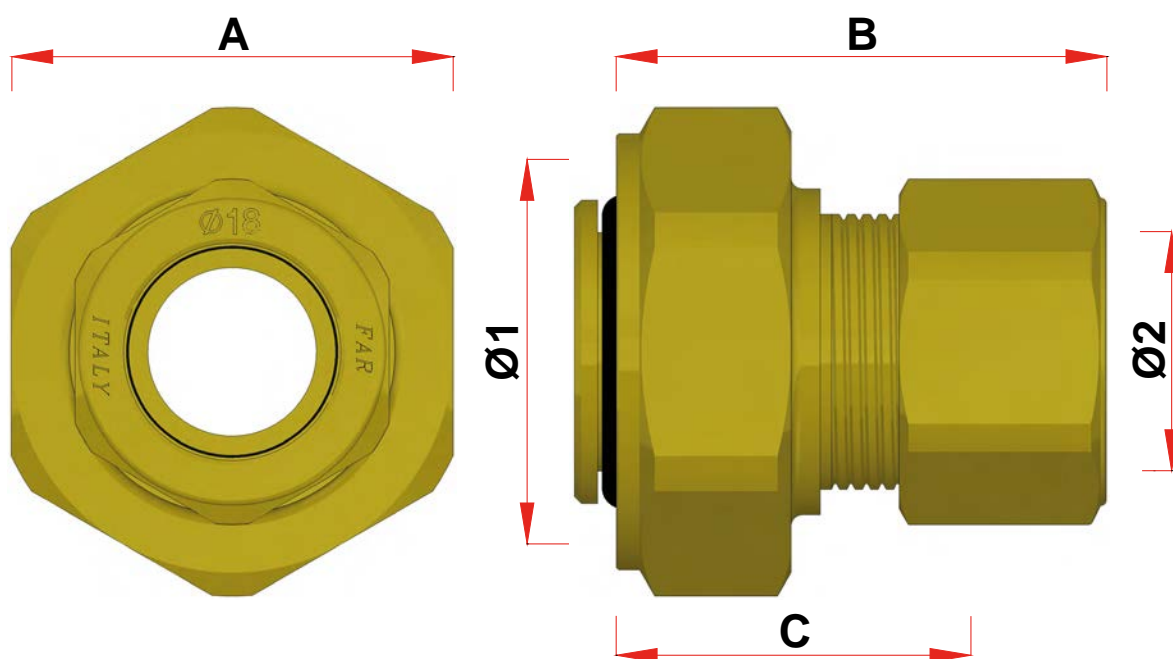

ART. 8851 G18-22

CODICE	Ø1	Ø2	A	B	C
8851 G1830	M33X1,5	24X19 Ø18	38	42	30
8851 G2230	M33x1,5	Ø22	38	45	30

Quote espresse in mm